



# CUSTOM CART COVER QUOTE FORM

Covers are custom made to **fit any** style, shape or size of cart using a variety of colors, materials, closures and options.

**For a Custom Quote Call: (800) 252-2692 or Fax: (541) 926-4361**

*Quotes effective for 30 days*

Company Name: \_\_\_\_\_

Name of person requesting quote: \_\_\_\_\_

Phone: \_\_\_\_\_ Fax: \_\_\_\_\_ Email: \_\_\_\_\_

Are you a:  Distributor  End-User

**Contact your local distributor or R.D. Bussard & Son, Inc., with the following information for your Custom Quotation:**

Quantity: \_\_\_\_\_ Cart Brand Name \_\_\_\_\_

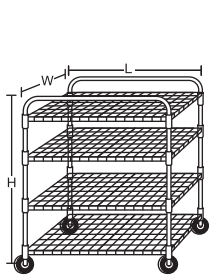

Style 1

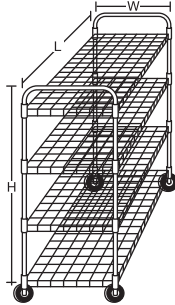

Style 2

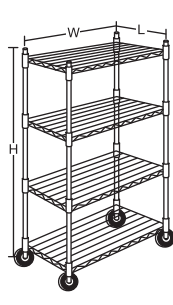

Style 3 (Square Corner)

*(Lakeside, Rubbermaid, etc.)*

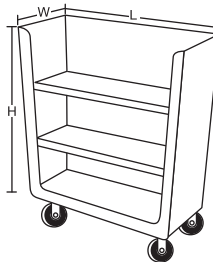

Turnabout Trucks

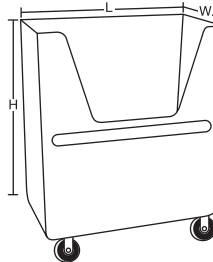

Bulk Delivery Trucks



Linen Carriers

**Cart Style** (see pictures above of some carts):

Style 1  Style 2  Style 3  Other: \_\_\_\_\_

**Dimensions:** Length \_\_\_\_\_ Width \_\_\_\_\_ Height \_\_\_\_\_

*(do not include casters)*

**Type of Fabric:**  Vicon-10™  Antimicrobial  200 Denier Nylon  400 Denier Nylon  
 Other: \_\_\_\_\_ Fabric Color: \_\_\_\_\_

**Type of Closure:**  Zipper  Hook & Loop Open on:  1 Side  2 Sides (front and back)

**Options:**  Clear Plastic ID Pocket 9"x12" Qty. (1 or 2): \_\_\_\_\_  Cart Handle Cut-Outs Qty. (1 or 2): \_\_\_\_\_

12" Clear Plastic Viewing Window  Full Clear Front Flap

Linen Side Pocket (size varies by cover)  One End  Both Ends

## R.D. Bussard & Son, Inc.

PO Box 206 Albany, OR 97321 • 415 25th Street SW • Albany, Oregon 97322

Toll Free: (800) 252-2692 • Local: (541) 926-7747 • Fax: (541) 926-4361 • sales@rdbussard.com

[www.rdbussard.com](http://www.rdbussard.com)



# CART COVER SPECIFICATION FORM

Company Name: \_\_\_\_\_ Attn: \_\_\_\_\_

Phone: \_\_\_\_\_ Fax: \_\_\_\_\_ Email: \_\_\_\_\_

### Measurements (in inches):

\_\_\_\_\_ Length (A) *Flap/opening will always be on length*

\_\_\_\_\_ Width (B) *Do NOT include any handles*

\_\_\_\_\_ Height (C) *Do NOT include any casters*

**NOTE:** Food Tray/Bun Rack Covers will often have flap/opening on the narrow side

### Handle Cutout Measurements (if applicable):

\_\_\_\_\_ Offset (D) *Top of cart to handle*

\_\_\_\_\_ Height of Handle (E)

\_\_\_\_\_ Height Below Handle (F) *Do NOT include any casters*

Handle Cutouts:  Yes  No

Number of Handles:  One\*  Two

\*If your cart only has one handle, look at the front of the cart.

Which side is the handle on?  Left  Right

\_\_\_\_\_ Width of Handle (G)

**NOTE:** C should equal D + E + F

### Measurements (Check one choice only for each):

Clear Front Flap:

Yes  No

Clear 12" Viewing Windows on main flaps of cover:

Yes  No

Linen Side Pockets 18"H (C) on bottom of width (B):

None  One side  Two sides

Clear 9"x 12" Card Holders

None  One side  Two sides

### Standard Options (Check one choice only for each):

Flaps on:  One side (front)  Both sides (front & back)

Flap Closure:  Velcro  Zipper

Slip-On Cover with no Flaps or Closures:  Yes  No

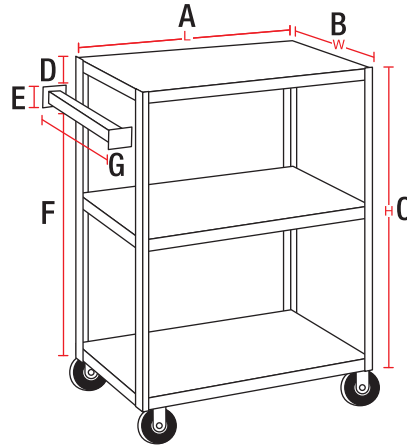

### Fill out if your cart has vertical handles:

When facing the front, which side are the handles on:

Left  Right

Front of cart

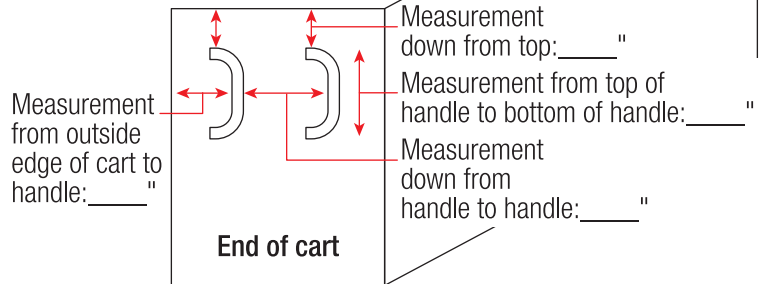

### Fabric/Color (Choose one):

**Vicon-10® Fire Retardant** (vinyl/nylon laminate)

Gray  Yellow  Red

**Antimicrobial Vinyl** (machine washing not recommended)

White  Gray/Green  Mint Green  Forest Green  
 Seafoam Green  Light Blue  Navy  Periwinkle Blue  
 Mauve  Rose  Beige  Cream

**200 Denier Fire Retardant Washable Nylon**

White  Pale Yellow  Light Blue  Mauve

**400 Denier Washable Nylon** (NON-Fire Retardant)

White  Royal Blue  Navy Blue  Burgundy  
 Red  Tan/Brown  Teal  Forest Green